

YM2203

FM Operator Type-N(OPN)

■ OUTLINE

OPN (FM OPERATOR TYPE-N) is a new type synthesizer which can produce all sounds required owing to the FM sound source system. It is provided with a built-in register which can store sound information and be connected easily with a microprocessor or microcomputer. It also comprises a square wave sound source different from the sound source according to the FM system and a noise generator.

■ FEATURES

- *The FM system sound source produce three different sounds simultaneously.
- *One of the above three sounds can be set to the mode by which specific sound effects and composite sine wave sound are synthesized.
- *Two programmable timers are incorporated.
- *8 bits general purpose input/output ports of two system are incorporated.
- *Three square wave sounds and white noise can be produced in addition to the FM system sounds.
- *Clock divider is built in so that wide operating frequency range is obtained.
- *Input and output are compatible with TTL.
- *Nch-Si gate MOS LSI is used.
- *Single phase power source of 5V is used.
- *This is compatible with software of YM2149 and AY-3-8910 and 8912 produced by GI.

■ TERMINAL DIAGRAM

GND	1	40	D0
D1	2	39	ϕS
D2	3	38	ϕM
D3	4	37	A0
D4	5	36	\overline{RD}
D5	6	35	\overline{WR}
D6	7	34	\overline{CS}
D7	8	33	IOB7
IOA7	9	32	IOB6
IOA6	10	31	IOB5
IOA5	11	30	IOB4
IOA4	12	29	IOB3
IOA3	13	28	IOB2
IOA2	14	27	IOB1
IOA1	15	26	IOB0
IOA0	16	25	\overline{IRQ}
AGND	17	24	\overline{TC}
ANALOG CHANNEL C	18	23	OP-O
ANALOG CHANNEL B	19	22	SH
ANALOG CHANNEL A	20	21	V _{DD}

■ BLOCK DIAGRAM

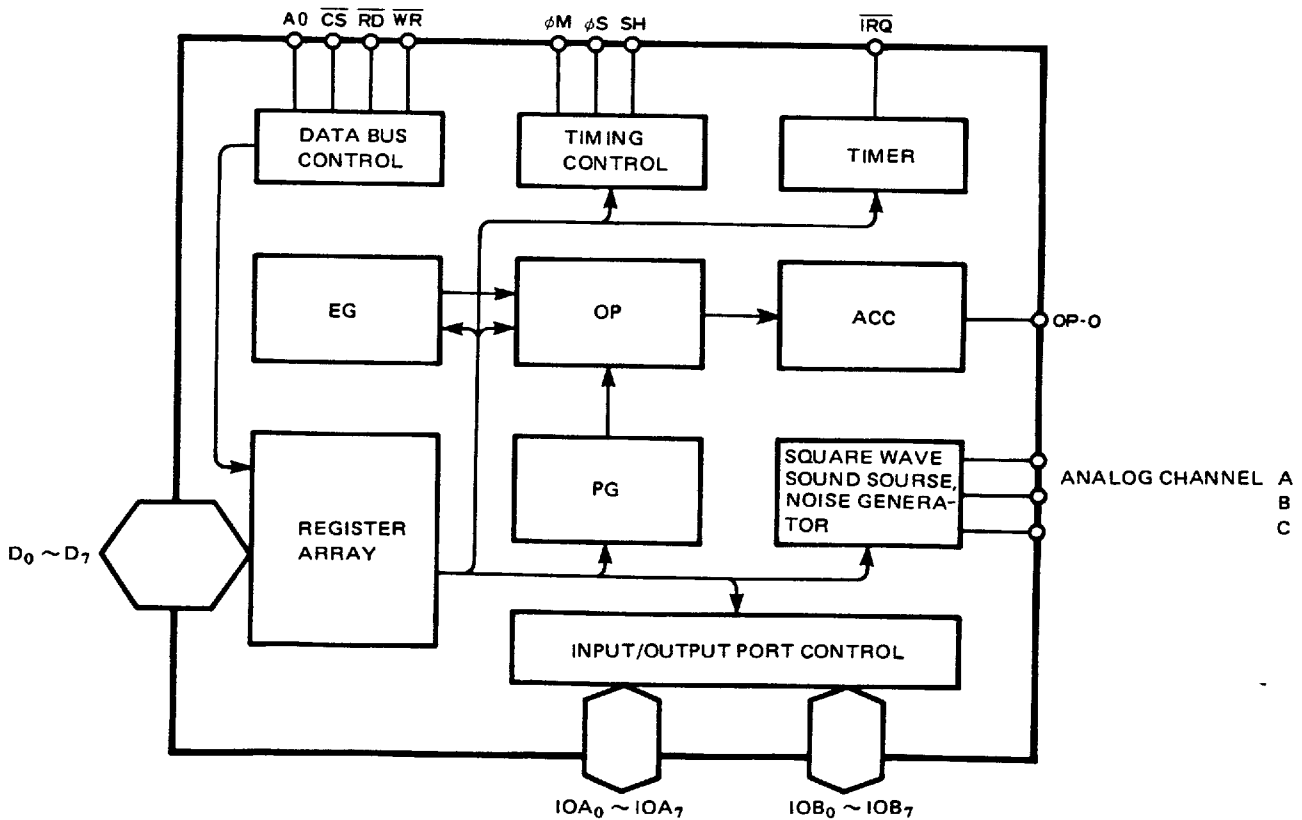

■ DESCRIPTION OF TERMINAL FUNCTION

1. ϕM

This is the master clock of the OPN. The FM sound source and square wave sound source operate, based on this clock. The maximum input frequency up to 4.2MHz can be input by using a built-in 1/6 divider.

2. $\phi S \cdot SH$

These are the clock (ϕs) and the synchronous signal (SH). They drive a D/A converter which converts digital output of the FM sound source into analog output.

3. D_0 through D_7

These 8-bit bi-directional bus exchange the data and address between the OPN and the micro-processor.

4. $\overline{CS} \cdot \overline{RD} \cdot \overline{WR} \cdot A_0$

These signals control bi-directional bus of D_0 through D_7 .

\overline{CS}	\overline{RD}	\overline{WR}	A_0	
0	1	0	0	Writes address into the register of the OPN.
0	1	0	1	Writes the register content into the OPN.
0	0	1	0	Reads the OPN status.
0	0	1	1	Reads the content of the OPN register.
1	x	x	x	D_0 through D_7 bus line become high impedance.

* Read enable register addresses 00 through 0F (16 bits).

5. \overline{IRQ}

This is an interrupt signal sent from two timers. It can be masked by the program.

6. \overline{IC}

This signal resets the system at low level. All the content of register array become "0".

7. OP-O

This outputs the FM modulated audio signal as 13-bit serial data. Accordingly, an external D/A converter is necessary.

8. Analog channel A, B and C

They are analog square wave audio signals. They can be mixed by setting resistance because of source follower.

9. IOA_0 through IOA_7 , IOB_0 through IOB_7

They are two sets of 8-bit input/output ports. Each terminal incorporates pull up resistance.

10. AGND

This is analog ground terminal for the D/A converter which is built in the square wave sound source section.

11. VDD

This is a power terminal of +5V.

12. GND

This is a ground terminal.

■ DESCRIPTION OF FUNCTIONS

The OPN is controlled based on the data written into the register. Accordingly, a microprocessor is free from the sound control operation except sending the data to the register.

The FM sound source determines a sound by the combination (modulation) of four sin waves. All the modulation systems such as feedback FM, simple FM and multiple FM are possible. In respect to the square wave sound source, this is compatible with YM2149 (SSG) and AY-3-8910 and 8912 (PSG.GI) in the use of the software. Therefore, function of the OPN can be improved by the exchange with the above LSI.

Each block of the OPN functions as follows.

- *Envelope generator (EG): Determines the modulation index of the envelope and modulation wave of the FM sound source.
- *Phase generator (PG): Determines the sin wave phase at each time step of the FM sound source.
- *Operator (OP): Calculates the $E \sin \theta$ value on the basis of the amplitude from the envelope generator and the phase from the phase generator.
- *Accumulator (ACC): Accumulates and adds operator output of each channel to mix each sound of the FM sound source and matches with the D/A converter.
- *Square wave sound source/noise generator:
Generates three different frequency square waves and pseudo-white noise. It can also mix noise and square wave. As for sound volume, it is possible to select either fixed sound volume (programmed value) or 10 pattern envelope producing mode. In this block, one D/A converter is provided for each sound.
- *Input/output port control: These are the general-purpose input/output ports to gets interface with external equipment.
- *Timer: Two types of timers are provided.

☆ Register content and address map

The OPN register is provided with the internal address as shown in the address map.

The content of each register (address) is as follows.

(1)	\$ 00 ~ \$ 05	Generates frequency of the square wave sound source.
(2)	\$ 06	Generates frequency of noise source.
(3)	\$ 07	Controls the input and output of the input and output ports and the output of musical sound and noise.
(4)	\$ 08 ~ \$ 0A	Controls sound volume. It is possible to select the fixed sound volume system (programmable) or the variable sound volume system.
(5)	\$ 0B ~ \$ 0C	Controls the envelope cycle in the variable sound volume sytem.
(6)	\$ 0D	Specifies the envelope shape in the variable sound volume system.
(7)	\$ 0E ~ \$ 0F	8 bit general-purpose input and output ports.
(8)	\$ 21	Test information, always set to "0".
(9)	\$ 24 ~ \$ 26	Gives the set time of Timers A and B.

■ 9945524 0002318 305 ■

(10)	\$ 27	Controls the operation of Timers A and B, and sets the third channel mode of the FM sound source.
(11)	\$ 2D ~ \$ 2F	Specifies the dividing number of the input clock. The dividing numbers 2 through 6 are for the FM sound source, and the numbers 1 through 4 are for square wave sound source.
(12)	\$ 30 ~ \$ 3E	Controls Detune and Multiple. This is used to set tones. This controls the relationship between the fundamental wave and harmonic.
(13)	\$ 40 ~ \$ 4E	Gives the total level. This information becomes the modulation index of the sound volume and modulation wave of the modulated wave.
(14)	\$ 50 ~ \$ 5E	Key -Scale controls the rate of change of A · D · S and R according to the keyboard information. Attack rate gives the rate of change of the envelope at the time of attack.
(15)	\$ 60 ~ \$ 6E	Decay Rate shows the rate of change of the envelope at the time of decay.
(16)	\$ 70 ~ \$ 7E	Sustain Rate shows the rate of change of the envelope at the time of sustain.
(17)	\$ 80 ~ \$ 8E	Sustain level shows the level of the shift from decay to sustain. Release rate shows the rate of change of the envelope at the time of release.
(18)	\$ 90 ~ \$ 9E	Generates the envelope including the repeat pattern similar to that of square wave sound source.
(19)	\$ A0 ~ \$ A6	Gives key-code (F-number) of each channel.
(20)	\$ A8 ~ \$ AE	Gives the key-code (F-number) of three channels when set to the special mode.
(21)	\$ B0 ~ \$ B2	Gives the modulation system (connection) of the FM modulation and the modulation factor of the feedback FM (self-feedback).

☆ FM system

In the FM system, musical sounds are synthesized by controlling various high harmonic waves by use of the frequency modulation.

The basic equation of the FM system is as follows.

$$F = A \sin (\omega C t + I \sin \omega M t) \quad - (1)$$

Where A is output amplitude, I is modulation index, and ωC and ωM are angular frequencies of carrier and modulator, respectively.

This equation can also be expressed as follows.

$$F = A [J_0 (I) \sin \omega C t + J_1 (I) (\sin (\omega C + \omega M) t - \sin (\omega C - \omega M) t) + J_2 (I) (\sin (\omega C + 2 \omega M) t - \sin (\omega C - 2 \omega M) t) + \dots] \quad - (2)$$

Where, $J_n (I)$ is the first class Bessel function of nth. As shown in the above equation, the FM system contains various harmonics and can control them.

The OPN provides the multiple FM modulation and feedback FM modulation shown in (3) and (4) in addition to the above FM modulation to produce every possible sound.

$$F = A \sin [\omega C t + I_1 \sin (\omega M_1 t + I_2 \sin \omega M_2 t)] \quad - (3)$$

$$F = A \sin (\omega C t + \beta F) \quad - (4)$$

* WRITE DATA

ADDRESS		COMMENT
21	TEST	LSI TEST DATA
24	TIMER-A	8 most significant bits of TIMER-A
25	TIMER-A	2 least significant bits of TIMER-A
26	TIMER-B	TIMER-B DATA
27	MODE RESET ENABLE LOAD	TIMER-A/B control and 3 channel mode
28	SLOT CH	Key-ON/OFF
2D		Set pre-scaler.
2E		Selection of the dividing numbers of 1/3 and 1/6.
2F		Set a divider to the dividing number of 1/2.
30	DT MULTI	Detune / Multiple (Addresses at 33, 37 and 3B are empty.)
3E		
40	TL	Total Level (Addresses at 43, 47 and 4B are empty.)
4E		
50	KS AR	Key Scale / Attack Rate (Addresses at 53, 57 and 5B are empty.)
5E		
60	DR	Decay Rate (Addresses at 63, 67 and 6B are empty.)
6E		
70	SR	Sustain Rate (Addresses at 73, 77 and 7B are empty.)
7E		
80	SL RR	Sustain Level / Release Rate (Addresses at 83, 87 and 8B are empty.)
8E		
90	SSG-EG	SSG-Type Envelop Control (Addresses at 93, 97 and 9B are empty.)
9E		
A0 A1 A2	F-Num. 1	F-Numbers / BLOCK
A4 A5 A6	BLOCK F-Num. 2	
A8 A9 AA	3CH * F-Num. 1	3CH-3slot F-Numbers / BLOCK
AC AD AE	3CH * BLOCK F-Num. 2	
B0 B1 B2	FB CONNECT	Self-Feedback / Connection

* READ / WRITE DATA

ADDRESS		COMMENT
00	Fine Tune	
01	Coarse Tune	
02	Fine Tune	
03	Coarse Tune	
04	Fine Tune	
05	Coarse Tune	
06	Period Control	
07	IN/OUT IOB IOA	/Noise /Tone /ENABLE
08	M	Level Channel-A Amplitude
09	M	Level Channel-B Amplitude
0A	M	Level Channel-C Amplitude
0B	Fine Tune	
0C	Coarse Tune	
0D	C ATT ALT HLD	Envelop Shape/Cycle
0E	I/O Port-A	
0F	I/O Port-B	
		Envelop Period
		Noise Period
		Channel-C Tone Period
		Channel-B Tone Period
		Channel-A Tone Period
		I/O Port Date

* READ DATA

ADDRESS		COMMENT
xx	BUSY	Status
	FLAG B A	

■ ELECTRICAL CHARACTERISTICS

1. Absolute Maximum Rating

ITEM	RATING	UNIT
Terminal voltage	- 0.3 ~ 7.0	V
Ambient operating temperature	0 ~ 70	°C
Storage temperature	- 50 ~ 125	°C

2. Recommended Operation Conditions

ITEM	SYMBOL	MIN.	STD.	MAX.	UNIT
Supply voltage	VDD	4.75	5.0	5.25	V
	VSS	0	0	0	V

3. DC Characteristics

ITEM		SYMBOL	CONDITIONS	MIN.	STD.	MAX.	UNIT
Input high level voltage	Total input	V _{IH}		2.0		V _{DD}	V
Input low level voltage	Total input	V _{IL}		- 0.3		0.8	V
Input leakage current	$\phi M, \overline{WR}, \overline{RD}, A_0$	I _L	V _{in} = 0 ~ 5V	- 10		10	μA
Three-State (off) input current	D ₀ ~ D ₇	I _{TSL}	V _{in} = 0 ~ 5V	- 10		10	μA
Output high level voltage	Output except \overline{IRQ}	VOH ₁	IOH ₁ = 0.4mA	2.4			V
		VOH ₂	IOM ₂ = 40μA	3.3			V
Output low level voltage	Total output	VOL	IOL = 2mA			0.4	V
Output leakage current (off)	\overline{IRQ}	IOL	VOH = 0 ~ 5V	- 10		10	μA
Analog output voltage	ANALOG-CHA, B, C	VOA	Max. Sound volume, no mixing	0.95		1.35	V _{pp}
Power current		IDD				120	mA
Pull-up resistance	IOA ₀ ~ IOA ₇ , IOB ₀ ~ IOB ₇ , $\overline{IC}, \overline{CS}$	RPU		60		600	kΩ
Input capacitance	Total input	C ₁	f = 1MHz			10	pF
Output capacitance	Total output	C ₀				10	pF

■ AC CHARACTERISTICS

4. AC Characteristics

ITEM		SYMBOL	CONDITIONS	MIN.	STD.	MAX.	UNIT
Input clock frequency	ϕM	f _C	Pre-scaler function (Fig. A-1)	0.7		4.2	MHz
Input clock duty	ϕM			40	50	60	%
Input clock rise time	ϕM	TR	(Fig. A-1)			50	ns
Input clock breaking time	ϕM	TF	(Fig. A-1)			50	ns

Access to FM sound source

ITEM		SYMBOL	CONDITIONS	MIN.	STD.	MAX.	UNIT
Address set-up time	A ₀	TAS	(Figs. A-2 and A-3)	10			ns
Address hold time	A ₀	TAH	(Figs. A-2 and A-3)	10			ns
Chip select write width	\overline{CS}	TCSW	(Fig. A-2)	200			ns
Chip select read width	\overline{CS}	TCSR	(Fig. A-3)	250			ns
Write pulse write width	\overline{WR}	TWW	(Fig. A-2)	200			ns
Write data set-up time	D ₀ ~ D ₇	TWDS	(Fig. A-2)	100			ns
Write data hold time	D ₀ ~ D ₇	TWDH	(Fig. A-3)	20			ns
Read pulse width	\overline{RD}	TRW	(Fig. A-3)	250			ns
Read data access time	D ₀ ~ D ₇	TACC	CL = 100pF (Fig. A-3)			250	ns
Read data hold time	D ₀ ~ D ₇	TRDH	(Fig. A-3)	10			ns
Output rise time	ϕ_s	TOR ₁	CL = 100pF (Fig. A-4)			200	ns
	OP-O, SH	TOR ₂	CL = 100 pF (Fig. A-5)			300	ns
Output rise time	ϕ_s	TOF ₁	CL = 100pF (Fig. A-4)			200	ns
	OP-O, SH	TOF ₂	CL = 100pF (Fig. A-5)			300	ns

Access to SSG sound source

ITEM		SYMBOL	CONDITIONS	MIN.	STD.	MAX.	UNIT
Address set-up time	A ₀	TSAS	(Figs. A-7 and A-8)	10			ns
Address hold time	A ₀	TAH	(Figs. A-7 and A-8)	10			ns
Chip select writh width	\overline{CS}	TSCSW	(Fig. A-7)	250			ns
Chip select read width	\overline{CS}	TSCSR	(Fig. A-8)	400			ns
Write pulse write width	\overline{WR}	TSWW	(Fig. A-7)	250			ns
Write data set-up time	D ₀ ~ D ₇	TSWDS	(Fig. A-7)	0			ns
Write data hold time	D ₀ ~ D ₇	TSWDH	(Fig. A-7)	20			ns
Read pulse width	\overline{RD}	TSRW	(Fig. A-8)	400			ns
Read data access time	D ₀ ~ D ₇	TSACC	CL = 100pF (Fig. A-8)			400	ns
Read data hold time	D ₀ ~ D ₇	TSRDH	(Fig. A-8)	10			ns

ITEM		SYMBOL	CONDITIONS	MIN.	STD.	MAX.	UNIT
Reset pulse width	\overline{IC}	TICW	(Fig. A-9)	72*			cycle

* Depends on the dividing number of prescaler.

$$\text{Pulse width} = (\text{dividing number}) \times 12$$

■ TIMING DIAGRAM (Timing is set on the basis of the values: $V_{IH} = 2.0V$ and $V_{IL} = 0.8V$.)

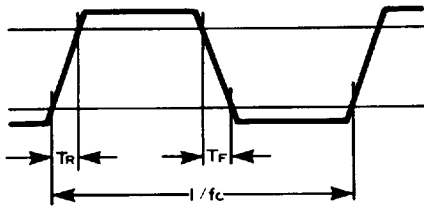

Fig. A-1 Clock timing

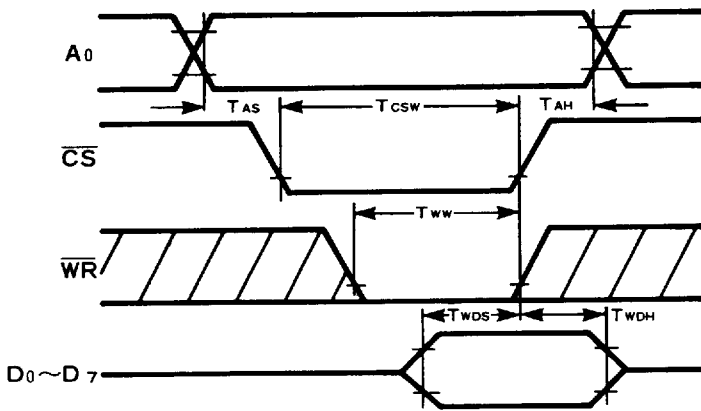

Fig. A-2 FM section write timing

Note.

T_{CSW} , T_{ww} and T_{WDH} are determined based on the time when either \overline{CS} or \overline{WR} goes to the high level.

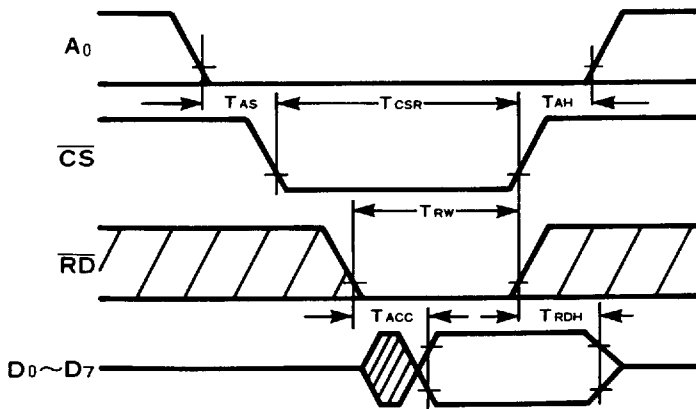

Fig. A-3 FM section read timing

Note.

T_{AAC} is determined based on the time when either \overline{CS} or \overline{RD} goes to the low level. T_{CSR} , T_{RW} and T_{RDH} are determined based on the time when either \overline{CS} or \overline{RD} goes to the high level.

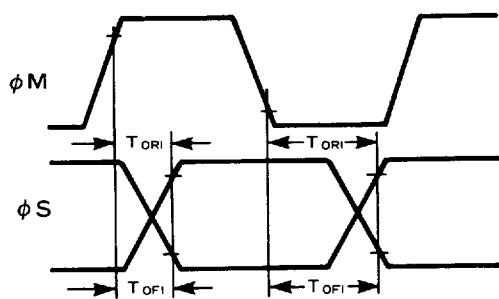

Fig. A-4-a ϕM and ϕS
(dividing numbers: 2 and 3)

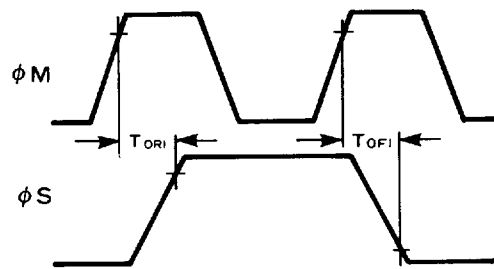

Fig. A-4-b ϕM and ϕS
(dividing number: 6)

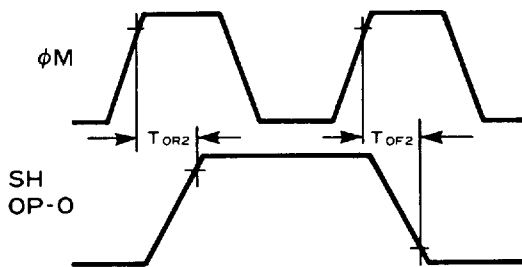

Fig. A-5 ϕM and SH · OP-O

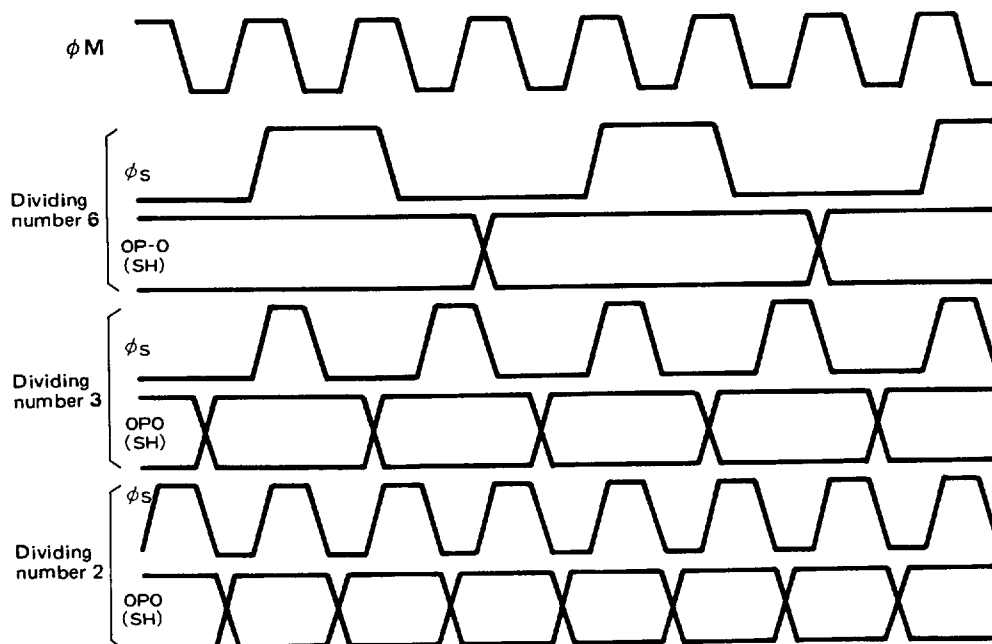

Fig. A-6 Timing of ϕS and OP-O/CH at each dividing number

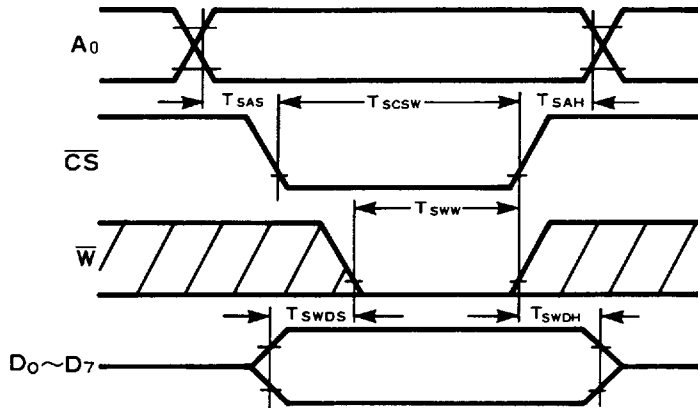

Fig. 6-7 SSG section write timing

Note.

T_{SWDS} is determined based on the time when either \overline{CS} or \overline{WR} goes to the low level.

T_{SCW}, T_{SWW} and T_{SWDH} are determined based on the time when either \overline{CS} or \overline{WR} goes to the High level.

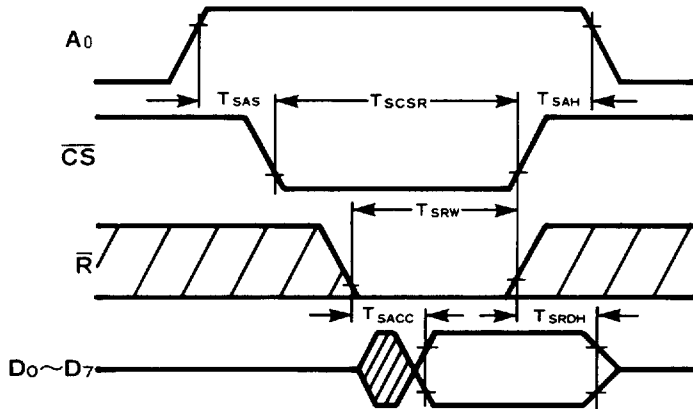

Fig. A-8 SSG section read timing

Note.

T_{SACC} is determined based on the time when either \overline{CS} or \overline{RD} goes to the low level. T_{SCSR}, T_{SRW} and T_{SRDH} are determined based on the time when either \overline{CS} or \overline{RD} goes to the High level.

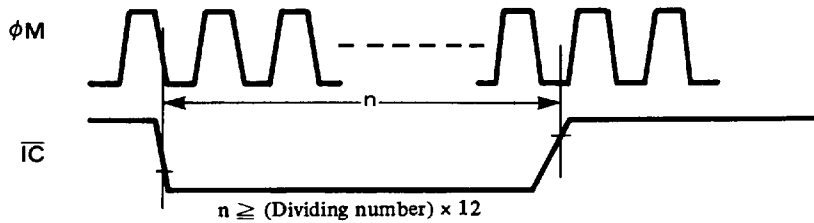

Fig. A-9 Reset pulse

■ OUTER DIMENSION DRAWING

